

HARDIN
MARINE

11 Industry Dr. Palm Coast, FL 32137
386-445-2500 / FAX 386-445-1122

PART NO.

137-8687

TITLE:

BRAVO GIMBAL MOUNT TRIM INDICATOR

www.hardin-marine.com

137-8687 STARBOARD SIDE SHOWN.
PORT SIDE IS 137-8647, ONLY
DIFFERENCE IS #1 137-8648 BRACKET

137-8653 STARBOARD
137-8648 PORT

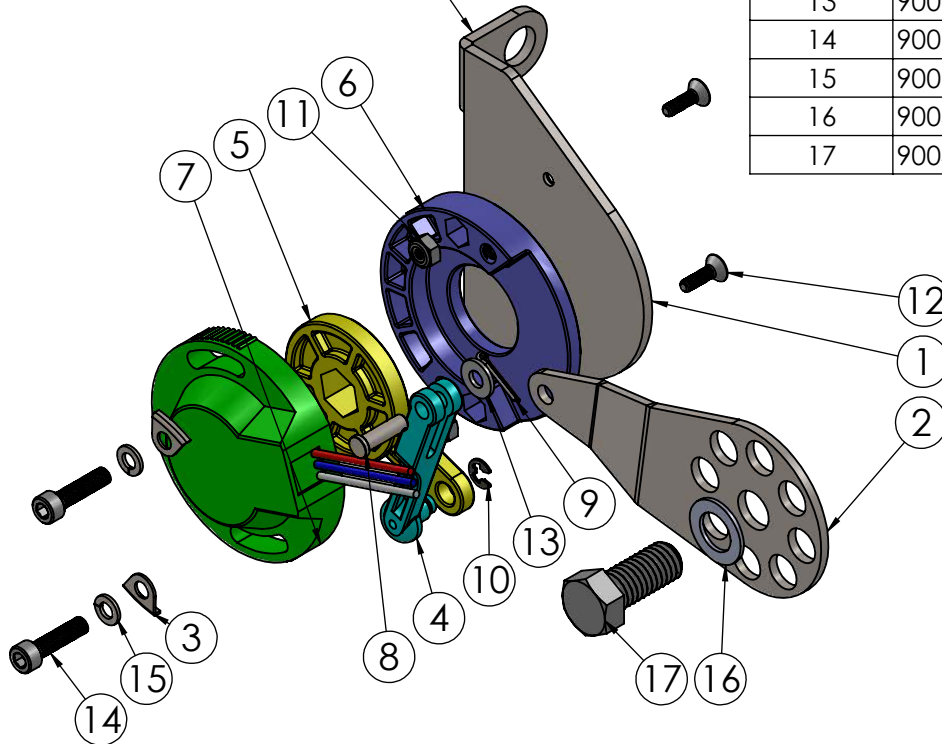

ITEM NO.	PART NUMBER	DESCRIPTION	QTY.
1	137-8653	MOUNT, BRAVO STBD TRIM SENSOR	1
2	137-8654	ARM, BRAVO TRIM ACTUATOR	1
3	525-57008	RETAINER	2
4	525-840843	LINK, ROD	1
5	525-840845	ARM, BRAVO TRIM SENDER	1
6	525-840846	HOUSING, TRIM SENDER	1
7	525-8M0095310	TRIM SENSOR	1
8	525-17-67297	PIN, CLEVIS	1
9	525-18-210711	COTTER PIN	1
10	620-60311	ECLIP, SHIFTER	1
11	90006CN-FNSS	NUT, 6-32	2
12	900-06C050SFS	BOLT, 6-32 x .50	2
13	90010AN-STSS	WASHER, #10 AN	1
14	90010F075SHS	BOLT, 10-32 x .75	2
15	90010SL-STSS	WASHER, #10	2
16	90043AN-STSS	WASHER, 7/16AN	1
17	90043C100HHS	BOLT, 7/16-14 x 1.00	1

THIS DRAWING IS CONFIDENTIAL AND IS SUPPLIED ON EXPRESS CONDITION THAT IT SHALL NOT BE LENT, COPIED OR DISCLOSED TO ANY OTHER PERSON OR USED FOR ANY OTHER PURPOSE WITHOUT WRITTEN CONSENT OF HARDIN MARINE INC.. BREACH OF THIS CONTRACT WILL HOLD AND IT'S PRINCIPALS LIABLE FOR LOSS AND DAMAGES.

HARDIN
MARINE

11 Industry Dr. Palm Coast, FL 32137
386-445-2500 / FAX 386-445-1122

PART NO.

137-8687

TITLE:

BRAVO ELECTRONIC TRIM SENDER

www.hardin-marine.com

THIS DRAWING IS CONFIDENTIAL AND IS SUPPLIED ON EXPRESS
CONDITION THAT IT SHALL NOT BE LENT, COPIED OR
DISCLOSED TO ANY OTHER PERSON OR USED FOR ANY OTHER
PURPOSE WITHOUT WRITTEN CONSENT OF HARDIN MARINE
INC.. BREACH OF THIS CONTRACT WILL HOLD AND IT'S
PRINCIPALS LIABLE FOR LOSS AND DAMAGES.

WARNING:
ATTACHING POWER TO
ANY OTHER WIRE THAN
THE RED OR GREY WIRE
WILL PERMENANTLY
DAMAGE THE SENDER
AND DASH PANEL.

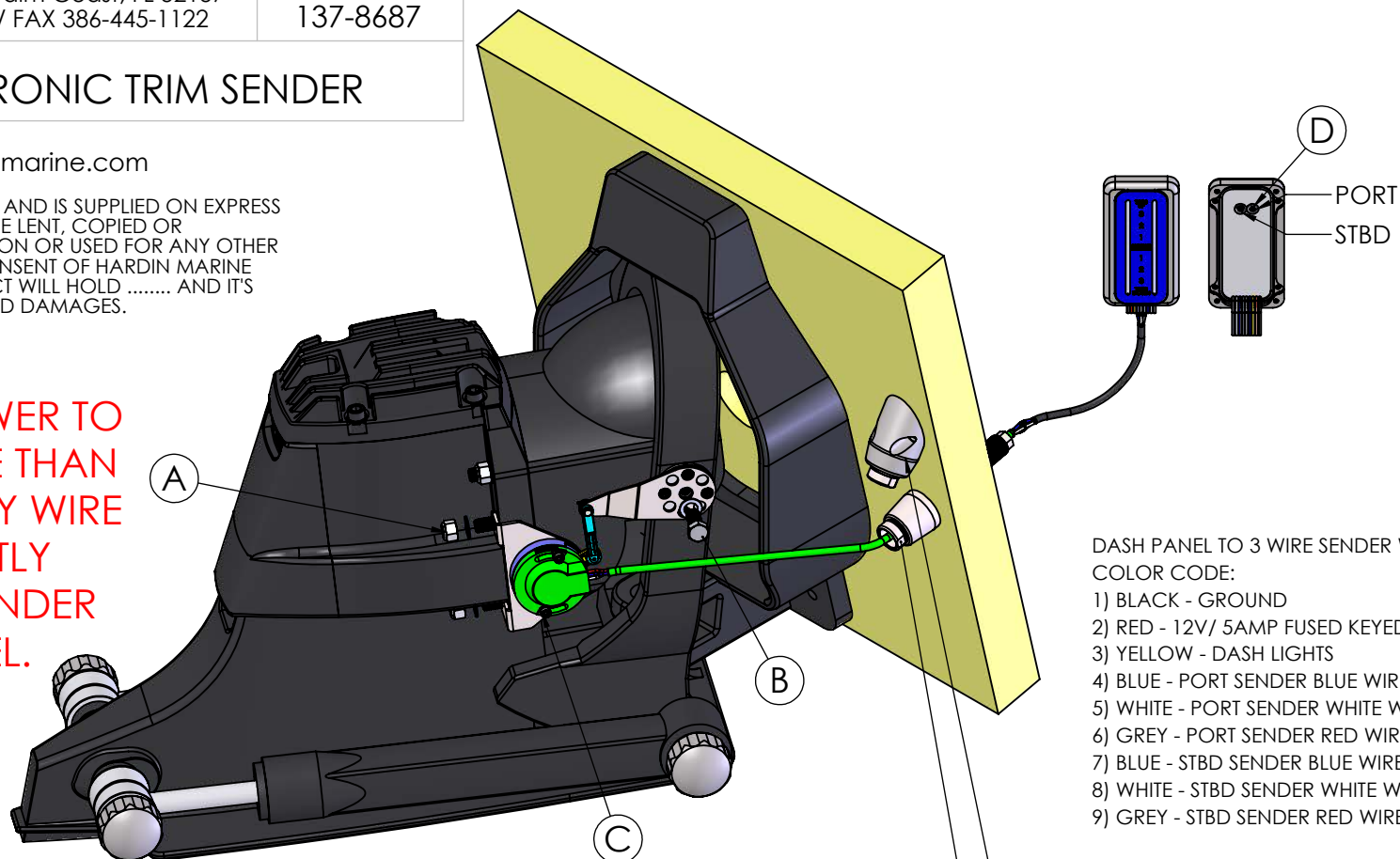

DASH PANEL TO 3 WIRE SENDER WIRE
COLOR CODE:

- 1) BLACK - GROUND
- 2) RED - 12V/ 5AMP FUSED KEYED POWER
- 3) YELLOW - DASH LIGHTS
- 4) BLUE - PORT SENDER BLUE WIRE
- 5) WHITE - PORT SENDER WHITE WIRE
- 6) GREY - PORT SENDER RED WIRE
- 7) BLUE - STBD SENDER BLUE WIRE
- 8) WHITE - STBD SENDER WHITE WIRE
- 9) GREY - STBD SENDER RED WIRE

INSTALLATION INSTRUCTIONS:

- 1) THE SENSOR AND ARM COMES PREASSEMBLED. STARBOARD SIDE SHOWN. PORT SIDE IS THE SAME INSTRUCTIONS.
- 2) IF STEERING RAMS ARE IN THE WAY, CAREFULLY REMOVE THEM.
- 3) REMOVE EXISTING NUTS, FIG. A. SLIDE BRACKET ASSEMBLY OVER STUDS. USING 5/8 SOCKET REINSTALL NUTS AND TORQUE TO 45 FT LBS..
- 4) LOWER OUTDRIVE TO THE LOWEST POSITION. INSTALL THE BRACKET TO THE PIVOT PIN, FIG. B, USING 5/8 SOCKET, SNUG BRACKET.
- 5) RAISE AND LOWER DRIVE TO PROPERLY POSITION THE PIVOT PIN BRACKET. YOU WANT TO MAKE SURE THE SENSOR ARM DOES NOT STOP WHILE THE DRIVE CONTINUES TO MOVE. MOVE SIDE TO SIDE TO MAKE SURE NO BIND IN THE BRACKET.
- 6) YOU CAN RUN THE SENSOR WIRE TO THE STOCK MERCURY INLET INSIDE THE GIMBAL HOUSING OR ONE OF THE SHOWN THRU HULLS, SOLD SEPERETELY.
- 7) WIRE THE TRIM SENDER TO THE DASH PANEL. SEE WIRE INFORMATION ABOVE. IF SINGLE DRIVE ,CONNECT BOTH SIDES OF THE DASH PANEL TO THE SINGLE SENDER.
- 8) LOWER THE DRIVE ALL THE WAY DOWN. USING 5/32 ALLEN KEY, LOOSEN SENDER BOLTS, FIG. C. ROTATE THE SENDER COUNTER CLOCKWISE UNTIL JUST THE BOTTOM LIGHT ON THE DASH PANEL IS LIT.
- 9) RAISE OUTDRIVE.
- 10) USING 1/16 ALLEN KEY REMOVE THE BACK COVER. USING A SMALL FLAT BLADE SCREWDRIVER, CAREFULLY ROTATE THE SCREWS COUNTER CLOCKWISE FIG. D. SOME LIGHTS WILL TURN OFF. NOW TURN THE SCREW CLOCKWISE TILL THE TOP LIGHT BECOMES ILLUMINATED.
- 11) CYCLE DRIVE UP AND DOWN TO MAKE SURE DASH PANEL IS ILLUMINATED THE FULL TRAVEL. NOW DO TO THE OTHER SIDE. ONCE DONE, REINSTALL REAR COVER AND INSTALL DASH PANEL.
- 12) REINSTALL STEERING RAMS. WIRE TIE THE TRIM SENDER TO THE TRIM RAM. MAKE SURE YOU ROTATE THE DRIVE LEFT AND RIGHT AND THE WIRES ARE NOT BINDING OR PULLING THE WIRES.

620-336180 45°

620-336181 STRAIGHT

HARDIN
MARINE

11 Industry Dr. Palm Coast, FL 32137
386-445-2500 / FAX 386-445-1122

PART NO.

137-8684

TITLE:

3 WIRE SENDER WIRING

www.hardin-marine.com

DASH PANEL TO 3 WIRE SENDER WIRE COLOR
CODE:

- 1) BLACK - GROUND
- 2) RED - 12V/ 5AMP FUSED KEYED POWER
- 3) YELLOW - DASH LIGHTS
- 4) BLUE - PORT SENDER BLUE WIRE
- 5) WHITE - PORT SENDER WHITE WIRE
- 6) GREY - PORT SENDER RED WIRE
- 7) BLUE - STBD SENDER BLUE WIRE
- 8) WHITE - STBD SENDER WHITE WIRE
- 9) GREY - STBD SENDER RED WIRE

WARNING:
ATTACHING POWER TO ANY OTHER WIRE THAN
THE RED OR GREY WIRE WILL PERMENANTLY
DAMAGE THE SENDER AND DASH PANEL.

USED IN 137-8144, 137-8687, 137-8689, 137-8690 & 137-8729 ACTUATOR KITS

ADJUSTING THE LED LIGHT RANGE FOR MERCURY SMARTCRAFT/3 WIRE SENDER:

- 1) MOVE THE DRIVE/TAB ALL THE WAY DOWN.
- 2) BOTH SENDERS MUST BE WIRED AND THE BOTTOM LIGHT ON BOTH SIDES MUST BE LIT. IF ONLY ONE SENDER IS BEING USED, WIRE BOTH SIDES OF THE DASH PANEL TO THE SINGLE SENDER.
- 3) ADJUST THE MERCURY SENDER SO THE BOTTOM LIGHT IS ON. WHEN TIGHTENING THE BOLTS, THE LIGHT MIGHT TURN OFF OR SHOW TWO LIGHTS. IF SO, LOOSEN BOLTS, ADJUST SENDER AND TIGHTEN BOLTS AGAIN. SENDER IS VERY SENSITIVE TO MOVEMENT.
- 4) MOVE THE DRIVE/TAB ALL THE WAY UP.
- 5) USING 1/16 ALLEN KEY, REMOVE THE BACK COVER.
- 6) USING A SMALL FLAT SCREWDRIVER, **CAREFULLY** TURN THE ADJUSTMENT SCREW ON THE BACK OFF THE LED PANEL ALL THE WAY COUNTERCLOCKWISE. SOME OF THE TOP LED'S SHOULD TURN OFF.
- 7) SLOWLY TURN THE ADJUSTING SCREW CLOCKWISE UNTIL THE THE TOP LED LIGHT BEGINS TO ILLUMINATE. PANEL IS NOW ADJUSTED FOR FULL RANGE. NOW ADJUST THE OTHER SIDE. CYCLE UP AND DOWN A FEW TIMES TO MAKE SURE LIGHTS ARE ADJUSTED PROPERLY.
- 8) REINSTALL REAR COVER.
- 9) 2 SLOT SHOWN. SAME INSTRUCTIONS FOR 4 AND 6 SLOT PANELS.

137-8684 HARNESS KIT COMES WITH:
(2) 30' SENDER HARNESS (GREY, BLUE
AND WHITE)
(1) 30' RED WIRE
(1) 5AMP FUSE AND HOLDER
(20) BUTT CONNECTORS

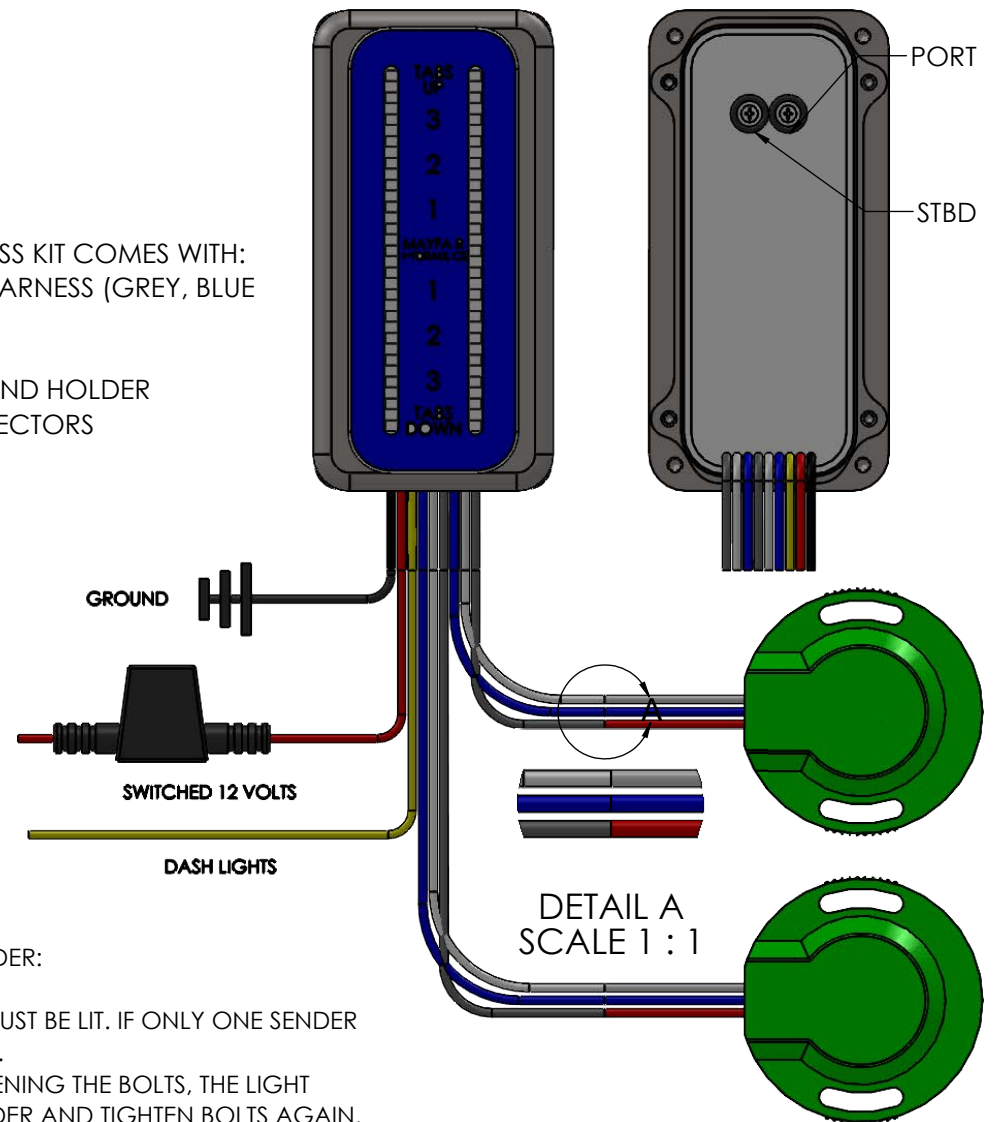

137-8729

IMCO GIMBAL / SCX 3 WIRE MERC SENDER

1. Prepare drive for installation by lowering the drive(s) to a level attitude, then remove steering rams at the back cap. Swing the rams to the side out of your way. Ensure that hydraulic lines are not kinked or damaged when swinging the rams. On multi engine boats, remove the tie bar.
2. Swing the drive to the left (port) to expose the gimble ring pivot pin.
3. Mount pivot pin bracket temporarily with supplied bolt. Only tighten the bolt snug, it will be removed later for final installation.
4. By hand, swing drive left and right to ensure bracket does not contact any part of transom housing or steering ram mount bolts.
5. Remove center and lower nut on the right (starboard) side of the drive. Leave the washers on the studs. Install lower bracket on studs and secure with nuts.

*****IMPORTANT***** There must be a washer between the drive and the bracket for proper alignment.

6. See picture on following page for visual reference.



Alignment

1. Due to slight variations in brackets, castings, and machining, it is important to adjust the alignment of the sender arm with the upper bracket. The goal is to align the forked plastic sender arm with the upper bracket. Perfect alignment prevents premature wear and ensures proper function. In the picture below, you can see the upper bracket needs to bend inwards slightly to align it with the slot in the plastic arm.



2. Bend the upper bracket inwards or outwards to achieve perfect alignment. In the example below, a few gentle taps with a soft facet mallet brings the bracket into alignment.



FINAL ASSEMBLY

1. The pivot pin needs to be installed from the inside out so the cotter pin is on the outside. To do this, you will need to remove the upper bracket and the sender from the lower bracket.
2. To remove the sender, unscrew the two Philips screws. Don't lose the lock washers or bent sheet metal retainers.
3. With the sender removed, connect the plastic arm to the upper bracket with the cotter pin and secure with the washer and cotter pin. See picture below.



4. Reinstall sender on to lower mount. Reinstall upper mount, using Loctite on the bolt threads.

5. Reinstall steering rams and tie bar. Secure sender wires to ram hoses as shown in the picture below. It is important to give the wire enough slack so the drive(s) can move fully left and right without binding or pulling the wires.

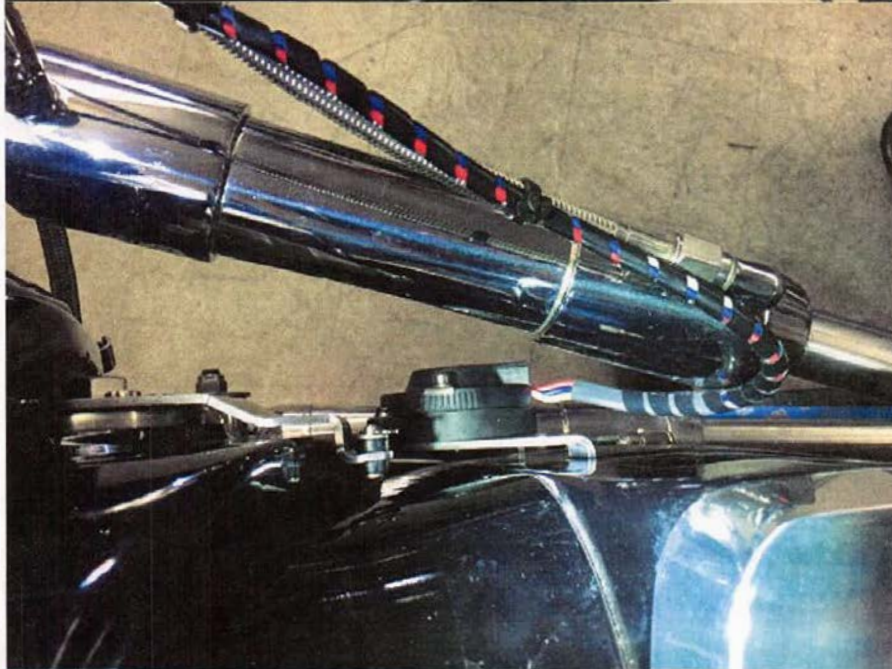

WIRING AND ADJUSTMENT

1. To get the wires through the transom you can reuse the slot in the transom and cable cover to pass the wires through the transom. You will have to cut the wires off the sending unit below the molded on white seal and add wires to extend through the transom. Ensure your splices are water tight, we suggest soldering the wires together and sealing with a marine grade heat shrink tube. The wires passed through the old cable hole in the transom should be sealed with silicone like the cable was.

2. Wiring up the indicator. The three wires out of the sender are:

Wire "A" = Red = 5+ volt

Wire "B" = White = Signal wire

Wire "C" = Blue = Ground

863187A 1/2

SMARTCRAFT TRIM POSITION SENSOR

IMPORTANT: This document guides our dealers, boatbuilders, and company service personnel in the proper installation or service of our products. If you have not been trained in the recommended servicing or installation procedures for these or similar Mercury Marine products, have the work performed by an authorized Mercury Marine dealer technician. Improper installation or servicing of the Mercury product could result in damage to the product or personal injury to those installing or operating the product.

NOTICE

After completing installation, place these instructions with the product for the owner's future use.

Models Covered

Model	Serial Number or Year
Gasoline engines	All DTS engines
	All 496 cid engines
Diesel engines	All QSD engines

Components Contained in Kit

Qty.	Description	Part Number
1	Trim position sensor	863187A1
1	TPA, 3-wire (retaining clip)	831957
1	Terminal connector block	830797 3

Replacing the SmartCraft Trim Position Sensor

Removal

1. Place the sterndrive in the full-in position.
2. Place the sterndrive in a full starboard turn.
3. Disconnect the trim position sensor wiring from the transom harness connector.
4. Remove and retain the clamp plate and hardware.

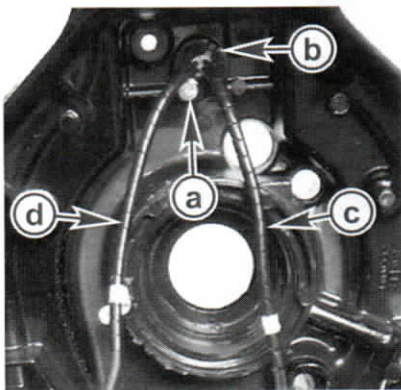

16572

Shown disassembled for clarity

- a - Screw
- b - Clamp plate
- c - Trim limit sender harness (starboard)
- d - Trim position sensor harness (port)

5. Pull approximately 30 cm (1 ft) of the trim position sensor harness out of the gimbal housing.

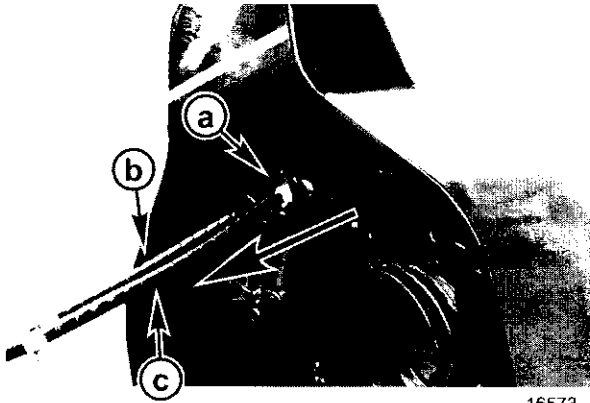

16573

Shown disassembled for clarity

- a - Clamp plate
- b - Trim position sensor harness (port)
- c - Trim limit switch harness (starboard)

IMPORTANT: Retain all the parts if the repair or replacement is done under warranty. Return both the sensor and harness for warranty credit.

6. Cut the trim position sensor harness just forward of the tapered plug. Do not remove the harness from the gimbal housing.
7. Remove and discard the trim position sensor and harness. Retain the screw, washer, and retainer.

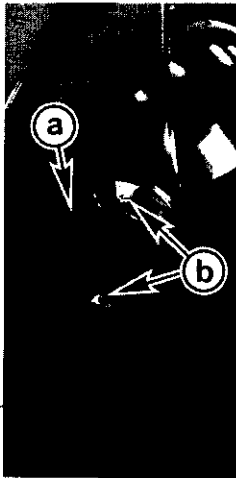

21076

- a - Trim position sensor
- b - Screw, washer, and retainer

Installation

1. Tape the connector end of the new sensor harness to the cut end of the old harness.
2. Pull the new harness through the gimbal housing using the old harness.
3. Remove and discard the old harness from the new harness.
4. Position the two grommet halves attached to the sensor wires with the seam vertically aligned and seat them in the gimbal housing grommet hole. Maintain light tension on the wires from inside the boat to hold the grommets in place.

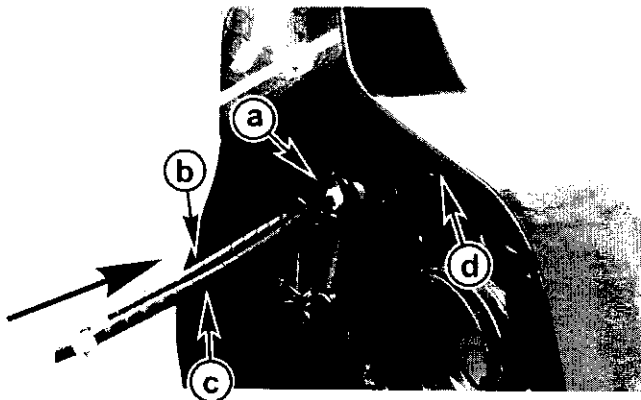

17975

Shown disassembled for clarity

- a - Clamp plate
- b - Trim position sensor harness(port)
- c - Trim sender harness (starboard)
- d - Grommet hole of the gimbal housing

5. Ensure that the trim position sensor wiring is positioned to the port side and that the trim position sender wiring is positioned to the starboard side of the gimbal housing.

6. Apply sealant to the screw threads and install the trim harness clamp plate. Tighten the screw to specification.

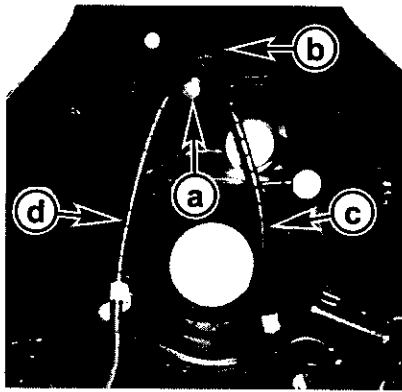

16572

Shown disassembled for clarity

- a - Retainer screw
- b - Clamp plate
- c - Trim position sensor harness (starboard)
- d - Trim sender harness (port)

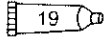
Tube Ref No.	Description	Where Used	Part No.
 19	Perfect Seal	Trim harness clamp screw	92-34227Q02

Description	Nm	lb-in.	lb-ft
Trim harness clamp screw	11	95	-

7. Install the trim position sensor as follows:
- a. Place the sterndrive in the full in position.
 - b. Place the sterndrive in a full starboard turn.
 - c. Align the index mark on the sensor body with the index mark on the rotor.

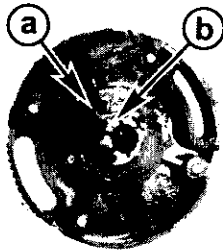

43379

- a - Index on sensor
- b - Index on rotor

- d. Install the trim position sensor and secure with the screw, washer, and retainer.

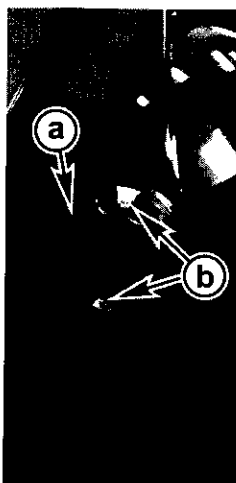

21076

- a - Trim position sensor
- b - Screw, washer, and retainer

8. Install the harness terminal leads into the harness terminal connector block of the trim position sensor as follows:
- a. Insert the terminal lead "A" into the terminal marked "A" on the terminal connector. Push the terminal lead into the terminal block until the terminal lead clicks into place and cannot be pulled out.
 - b. Repeat step "a" for terminals "B" and "C" and ensure that all 3 terminals are securely locked.
 - c. Place the terminal lead retaining clip over the leads at the rear of the terminal connector block.

- d. Push the retaining clip onto the terminal connector block until it snaps into place over the locking tabs located on either side of the terminal connector block.

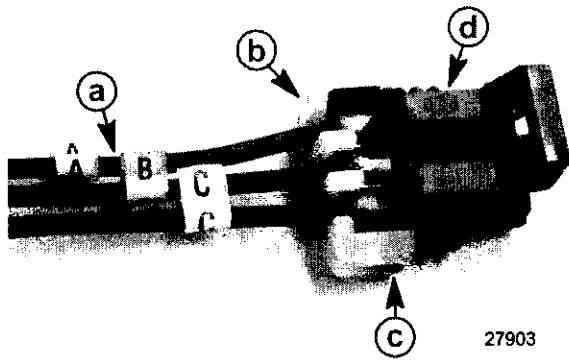

- a - Trim position sensor harness leads
- b - Retaining clip
- c - Locking tab
- d - Terminal connector block

9. Connect the trim position sensor connector to the transom harness connector.
10. Secure the trim position sensor harness to the water hose with the plastic retaining clip.

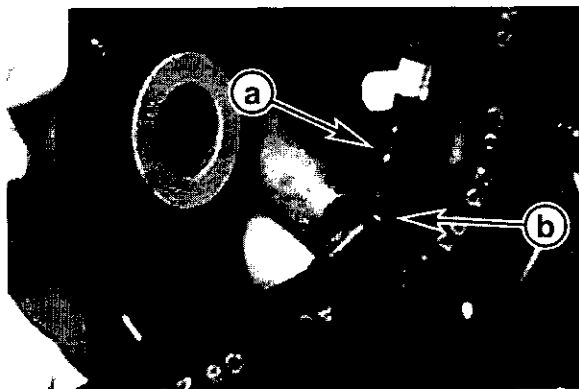

- Shown disassembled for clarity
- a - Trim position sensor harness
 - b - Retaining clip

Adjusting the Trim-Position Sensor on Gasoline Engines

Adjusting the Trim Position Sensor on DTS Engines

1. Before connecting the CDS, turn the ignition key to the "ON" position.
2. Since no limits have been set yet, position an observer at the rear of the boat to make sure the sterndrive will not make contact with the swim platform or ground during this test.
3. Trim drive fully up and down as far as mechanically possible without allowing the drive to contact any obstacles or until the drive reaches the mechanical limits of travel one complete cycle. Do not make contact with the swim platform while trailering up, and do not make contact with the ground trimming in.
4. Once the cycle is complete, key off and move the control lever to reverse wide open throttle for 10 seconds to completely power down the PCM.
5. Connect the CDS to the engine diagnostic connector.
6. Turn the ignition key to the "ON" position.
7. Select the appropriate engine set-up on the CDS.
8. Select "Tool Box" and go to the "Data List" screen.

9. Select Trim Position —% and Trim Position—Counts.

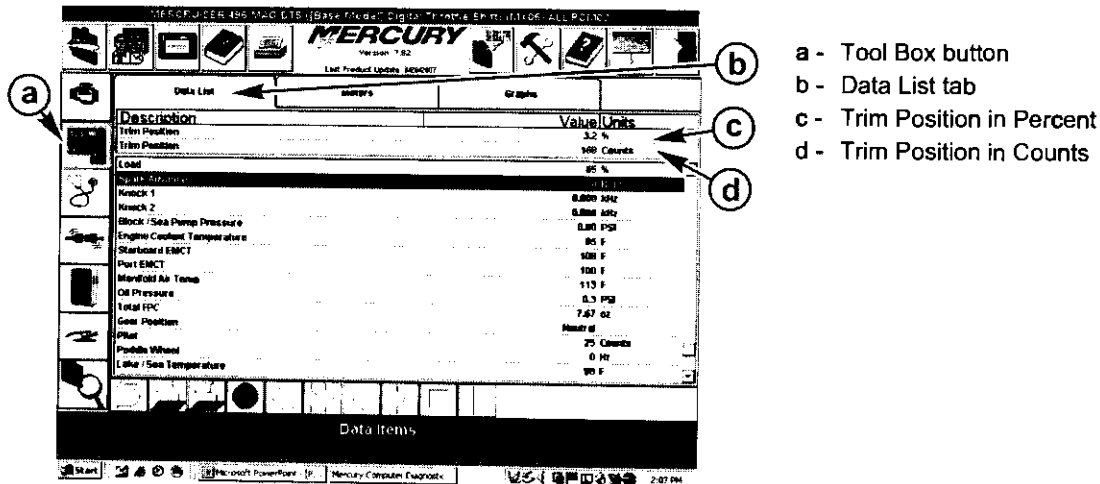

43222

10. Trim the drive to the full down position and continue to run the pump for 3 more seconds.
11. Note the number in the trim position counts display. The counts should be between 130 and 150. If the counts are out of this range, loosen the screws and adjust the sensor until counts are within this range. Tighten screws.

Diagnostic Display	Counts
Trim position (TRIM POS) counts in full down position	

Setting Trailer Limit on DTS Engines

IMPORTANT: Incorrectly configuring the trim limit using the CDS can create a programming error in the engine's PCM. Always set the trailer limit before setting the trim limit. If you configure the trailer limit incorrectly, contact the Mercury Marine Technical Service Department for further instructions.

Trailer limit settings establish the maximum trailer up position of the sterndrive to prevent sterndrive to boat contact or damage.

Setting Trailer Limit

IMPORTANT: Set the trailer limit before the trim limit.

1. Go to the "Active Diagnostics" screen and select "Trailer Limit." When you click "Run" a red window will appear. Select "Proceed."

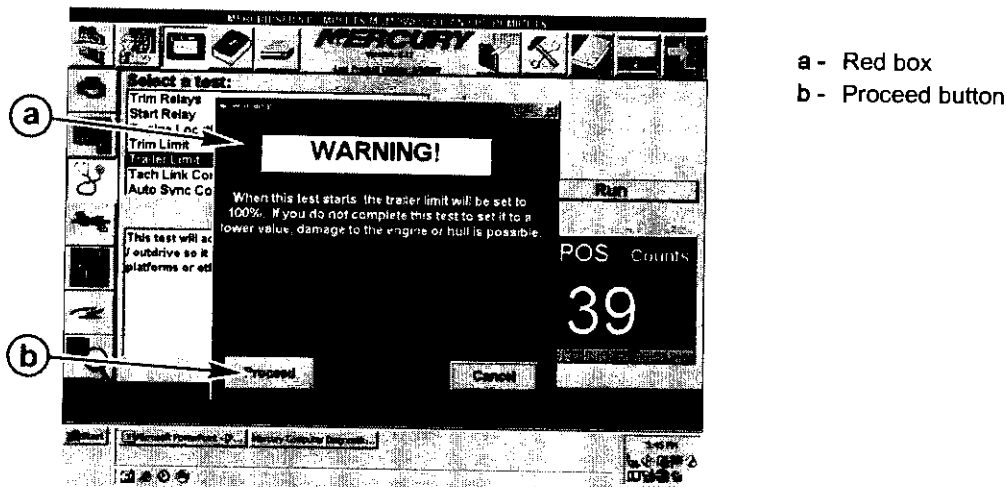

43223

2. A blue screen will appear. Follow the instructions and trim the drive fully in, operating the pump for 3 seconds after the mechanical limit has been reached. Click "OK" to continue.
3. Trim the drive to full up trailer position, ensuring there is clearance between the drive and the swim platform. The trailer position at the top may not read the full 100% on the CDS due to the celery stick position. Click "OK" to continue.
4. A blue screen will appear. Follow the instructions on the screen. Turn the ignition key to the "OFF" position and move the remote lever to the reverse, wide open throttle position for 10 seconds to store the new values in the ECM. Click OK to continue.

- Turn the keyswitch to the "ON" position to confirm that the new settings have been stored in the ECM. The text at the bottom of the screen will change from red to blue when complete.

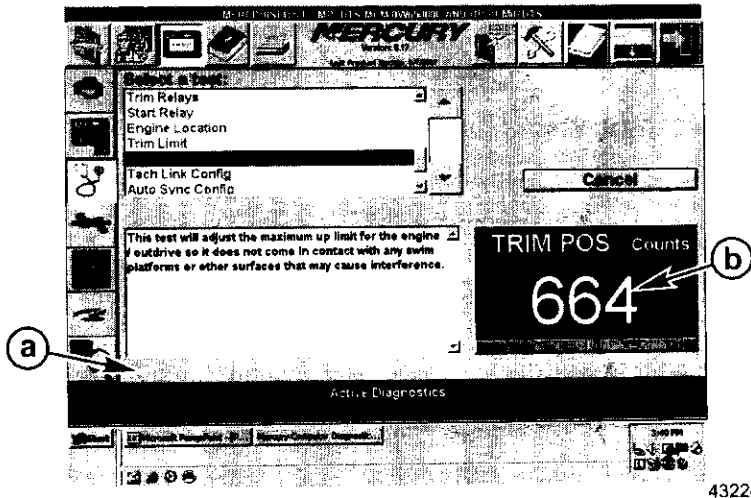

- a - Writing changed from red to blue
- b - Trim counts

Setting Trim Limit

- Go to the "Active Diagnostics" screen and select "Trim Limit."

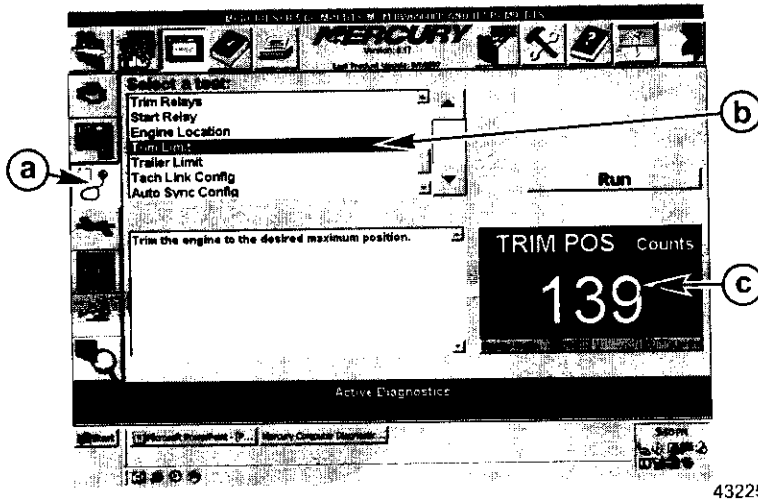

- a - Active Diagnostics button
- b - Trim Limit
- c - Trim position counts

- A blue screen will appear. Follow the instructions on the screen and trim the drive in fully. Continue to operate the pump for 3 seconds after reaching the mechanical limit. Click "OK" to continue.

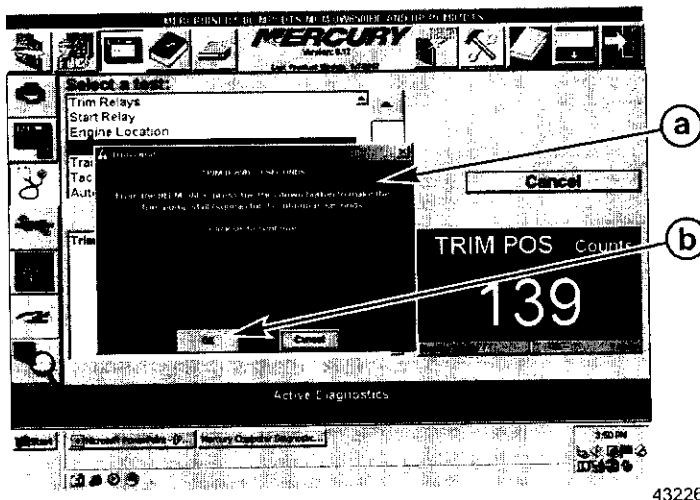

- a - Blue box
- b - OK button

- Trim the drive out until the distance between the trim cylinder anchor pin centers is 55.3 cm (21 3/4 in.) or less.



43227

Anchor pins

- Once the measurement is confirmed, follow the instructions in the blue window. Turn the ignition key to the "OFF" position and move the remote lever to the reverse, wide open throttle position for 10 seconds to store the new values in the ECM.
- Confirm that the new settings have been stored in the ECM. The text at the bottom of the screen will change from red to blue when complete.

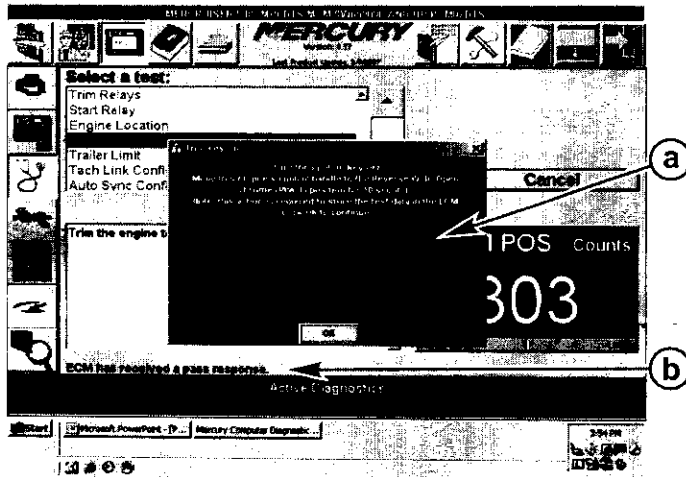

- a - Blue box
- b - Text changed from red to blue

43228

Trim Limit Set Failure

- If the settings are not stored in the ECM, or the count difference is greater than 180, the pass response stays red and indicates a failure.

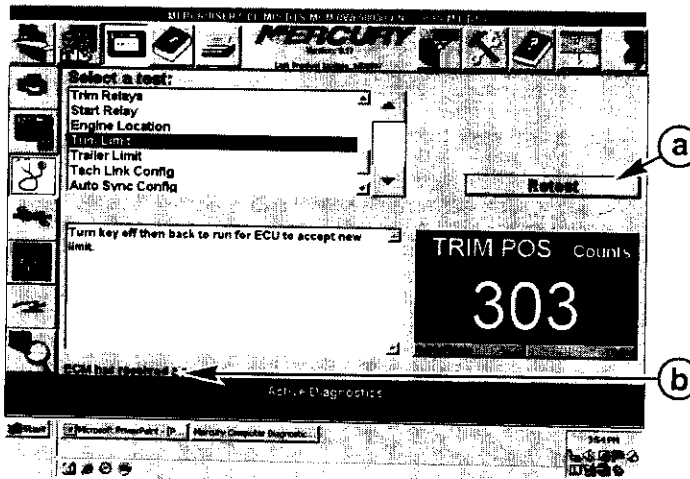

- a - Reset button
- b - Red wording indicating failure

43229

- Move the drive to full out trim limit and record counts from the **TRIM POS** window in table below.
- Subtract the initial counts recorded during **Setting Trailer Limit** of this procedure.

Example

Diagnostic Display	Counts
Counts at trailer limit (full up), anchor pin centers at 55.3 cm (21 3/4 in.) or less	303 counts (From Setting Trim Limit , step 5)
Minus counts at trim limit (full down)	139 counts (From Setting Trailer Limit , step 7)
Difference. (Should be less than or equal to 180)	164 counts (Less than 180 counts—Pass)

Calculation

Diagnostic Display	Counts
Counts at trailer limit (full up), anchor pin centers at 55.3 cm (21 3/4 in.) or less	
Minus counts at trim limit (full down)	
Difference (Should be less than or equal to 180)	

- The difference should be 180 counts or less. If greater than 180, reset trim limit. Verify that the drive extension at trim limit is at or less than 55.3 cm (21 3/4 in.) between anchor pins centers.

Adjusting the Trim Position Sensor on Non-DTS Engines

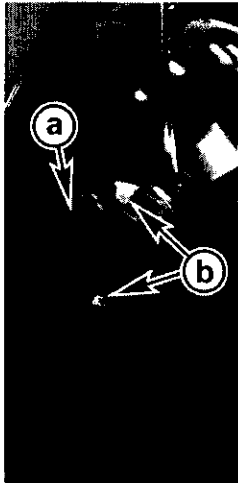

21076

- a - Trim position sensor
- b - Retaining screws

- Trim the sterndrive unit to the full in trim limit position, 55.3 cm (21 3/4 in.) or less.
- Remove the weather cap from the Diagnostic Link connector and connect the DDT Scan Tool.
- Turn ignition key switch to the RUN position.
- Set the scan tool to display TRIM POS counts and note the value displayed.
- TRIM POS counts must be 89 counts on the DDT, or 356 counts on the CDS.
- If TRIM POS counts are correct, proceed to step 7. Otherwise:
 - a. Loosen both trim position sensor retaining screws.
 - b. Rotate the trim position sensor until TRIM POS counts are at the specified value.
 - c. Tighten the trim position sensor retaining screws.
 - d. Verify TRIM POS counts are still within the specified range. Repeat steps "a" through "c" if necessary.
- Turn the ignition key switch to the OFF position, disconnect the scan tool from the Diagnostic Link connector, and install the weather cap in the Diagnostic Link connector.

Trim Calibration—Diesel Engines

Checking Trim and Trailer Limits

Test the operation of the trim position sender by moving the drive through its full range of motion, using caution as it reaches the upper and lower limits. If the limits are outside the original specifications adjust the limits as follows.

Setting Trim Limit with CDS

The trim limit configures the system integration module (SIM) to control the maximum up trim limit. The trim limit function is only supported if the SIM has input for the three wire trim sensor.

NOTE: *The trim position sender will automatically be adjusted by setting the trim and trailer limits*

1. Connect the CDS to the SmartCraft junction box located at the vessel helm.
2. Turn the ignition key to the "RUN" position.
3. Select "Make" Cummins MerCruiser Diesel.
4. Select the appropriate System Integration Module (SIM) model in the CDS engine select screen.
5. Open the Tool Box icon in the CDS.
6. Open the Active Diagnostics icon.
7. Scroll down the Active Diagnostics window and highlight "Trim Limit."
8. Follow the CDS on screen instructions and run the the test.

Setting Trailer Limit with CDS

The trailer limit function is designed to limit the maximum trailer up position, preventing damage to swim platforms or other equipment.

NOTE: *The trim position sender will automatically be adjusted by setting the trim and trailer limits*

1. Connect the CDS to the SmartCraft junction box located at the vessel helm.
2. Turn the ignition key to the "ON" position.
3. Select "Make" Cummins MerCruiser Diesel.
4. Select the appropriate System Integration Module (SIM) model in the CDS engine select screen.
5. Select the correct engine location.
6. Open the Tool Box icon in the CDS.
7. Open the Active Diagnostics icon.
8. Scroll down the Active Diagnostics window and highlight "Trailer Limit."
9. Follow the CDS on screen instructions and run the the test.

MAYFAIR PERFORMANCE

PART NO.

TITLE: 2 SLOT DASH PANEL CUTOUT

www.hardin-marine.com

USE 1/4 DRILL BIT FOR MOUNTING HOLES

DASH PANEL OUTSIDE PROFILE

USE 1/2 DRILL BIT FOR WIRE SLOTS. USE JIGSAW TO CUTOUT BETWEEN THE 2 HOLES.

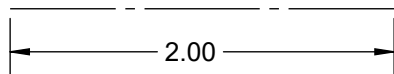

MAKE SURE PRINTER IS SET TO 1:1 SCALE WHEN PRINTING. MEASURE THIS LINE TO INSURE CORRECT SCALE.

